

1300103001
 1300103003
 1346103005

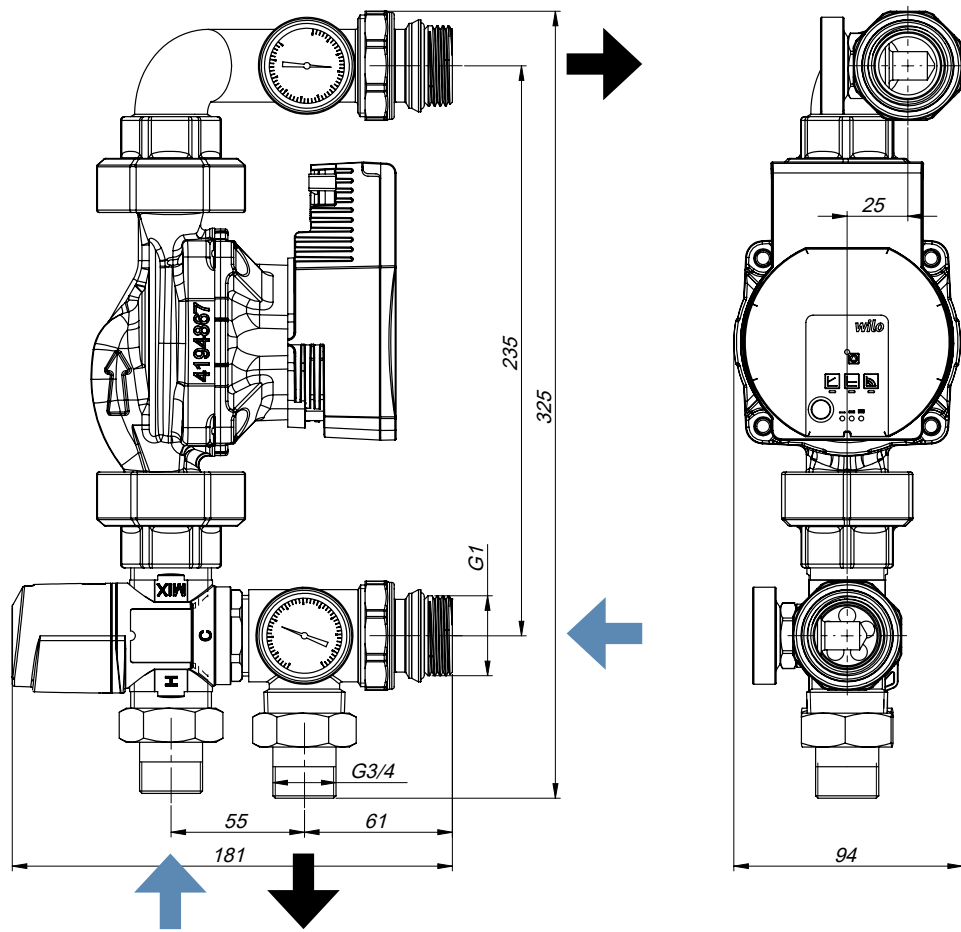

ATM 361 Kvs 1,6 (20 – 43 °C)
ATM 561 Kvs 2,5 (20 – 43 °C)
ATM 363 Kvs 1,6 (35 – 60 °C)

Set	ATM 361 ATM 561	ATM 363
1	20 °C	35 °C
2	25 °C	44 °C
3	30 °C	48 °C
4	34 °C	51 °C
5	38 °C	57 °C
6	43 °C	60 °C

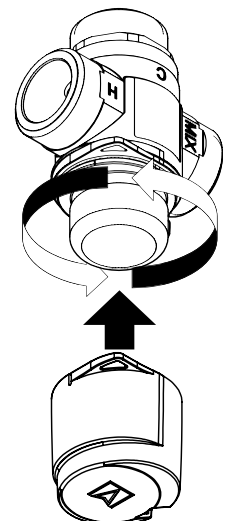
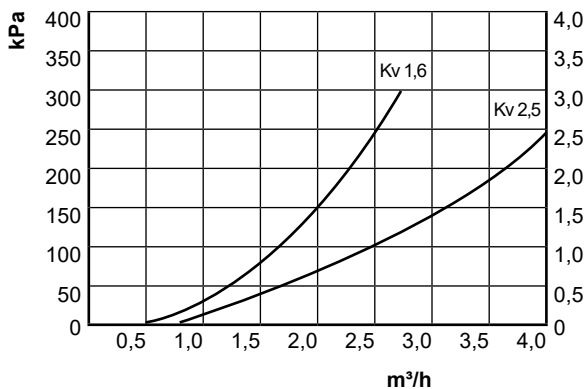

2001-V2.1-INST-GRUP_P1

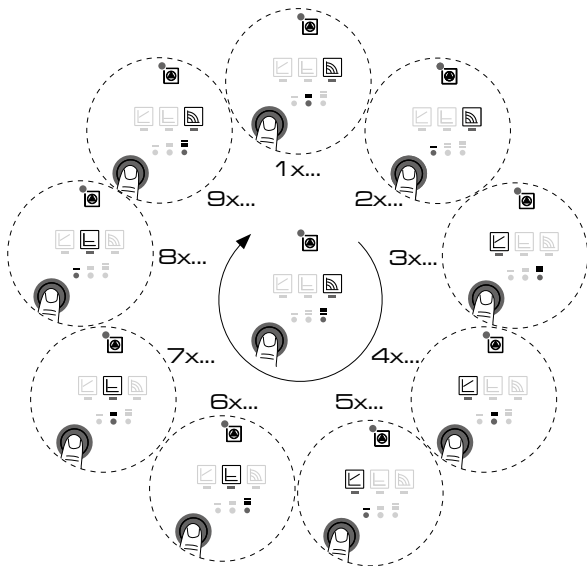

T_{max}	=	90 °C
P_{max}	=	10 bar
H ₂ O		100%
Glycol		max 50%



Stala różnica ciśnienia
Constant differential pressure $\Delta p-c$
Постоянный перепад давления $\Delta p-c$

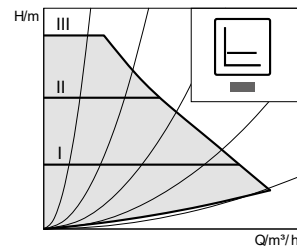

Ustawienie zalecane
 Установка рекомендуется
 Recommended setting



Proporcjonalna różnica ciśnienia $\Delta p-v$
Differential pressure variable $\Delta p-v$
Пропорциональный перепад давления $\Delta p-v$

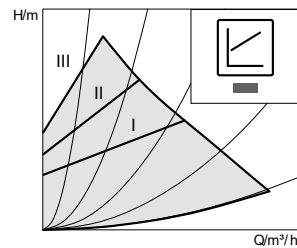

Ustawienie niezalecane
 Setting not recommended
 установка не рекомендуется



Stala prędkość
Constant speed
Постоянная скорость

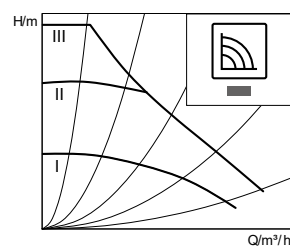

Ustawienie niezalecane
 Setting not recommended
 установка не рекомендуется